

BMW 2008
The all-new
1 Series Coupe

128i
135i



The Ultimate
Driving Machine®

Year One of the 1.
The all-new 2008 1 Series Coupe.



1 Series Coupe Product Ordering Guide

Confidential information for use by authorized BMW centers. Please note: images shown are low resolution. Due to color monitor and printer capabilities, colors shown may not appear on screen and print out accurately. Vehicle images in this Product Ordering Guide booklet may not be U.S. spec.

Courtesy of:
www.1addicts.com

Celebrating the innovative ideas and driving fun that started with America's first BMW.

Forty years after the 2002tii arrived in the U.S. and launched the sports sedan concept, BMW brings the true essence of driving enjoyment to a new level with the introduction of the 1 Series Coupe: a dynamic four-seater with clean, sporty lines, a classic interior, and a passion for performance.

The 1 Series comes with a choice of two powerful and fuel-efficient six-cylinder engines, two 6-speed transmissions, and dozens of ways for customers to express their personalities through distinctive paints, upholsteries and optional features. But no matter how it's configured, the BMW 1 Series delivers the ultimate driving experience.





A pure reflection of the joy of driving.

The all-new 2008 1 Series Coupe melds classic BMW design elements with striking, new touches. A long hood, distinctive shoulder line and short overhangs underscore its sporty attitude. At night, Corona headlight-rings announce its arrival, while LED taillight clusters signal its departure. Four new Star Spoke cast alloy wheel styles add eye-catching interest.

The 135i is differentiated from the 128i by its aero kit with integrated rear spoiler, Xenon Adaptive Headlights with Cornering Lights,¹ and high-intensity headlight washers. Its handling enhancements include performance-tuned DSC, 18-inch wheels with performance tires, and sport suspension calibration with high-performance brakes.

¹Standard in 135i, optional in 128i.



Get in. Get with it.

The cabin: Dynamic style meets pure comfort and luxury. Optional Boston Leather upholstery is available in five rich colors, accented by Gray Poplar Wood, or optional Aluminum or Burl Walnut Wood interior trims. Eight-way adjustable front seats can be enhanced with optional power and four-way lumbar support. Included in the optional Sport Package: eight-way front sport seats with adjustable side bolsters, to hold you tight in curves.

The two-way power glass moonroof and 60/40 split-folding rear seats come standard. An optional Premium Package adds the pleasures of power seats with memory, Ambiance Lighting, auto-dimming mirrors with digital compass, three-button garage-door opener, and BMW Assist™ and Bluetooth® wireless technology.

A treat for the senses.

With the key in your pocket, optional Comfort Access lets you enter the 1 Series interior and ignite the engine at a touch. Look around: the driver-oriented gauges and controls are not just functional; they're rimmed with galvanized pearl gloss trim. An optional Navigation system provides the ease of accessing comfort functions via Voice Command or the six programmable memory keys included with iDrive. In addition to the standard

audio system, an optional premium stereo system takes the acoustics to a higher level; both allow MP3 play through the standard auxiliary input. An optional iPod® and USB adaptor lets you access songs and playlists from the steering wheel. And optional HD Radio™ and SIRIUS Satellite Radio let you expand your listening selections.

European interior shown.



The heart of high performance, with heart to spare.



Under the hood of the 135i, BMW's award-winning twin-turbo 3.0-liter inline six with direct fuel injection draws on 300 hp, generating 300 lb-ft of torque from 1400-5000 rpm; it propels the 135i from 0-60 mph in just 5.1 seconds.¹ Using a high-precision fuel injection system, every ounce of fuel is maximized, making the twin-turbo engine more efficient and overcoming the traditionally poor gas mileage of turbocharging. Another potent 3.0-liter inline six – a 230-hp Valvetronic powerplant capable of 200 lb-ft of torque at 2750 rpm – powers the 128i from 0-60 in 6.1 seconds.²

Both models offer a choice of 6-speed transmissions. The silky-shifting manual comes standard, or choose the optional STEPTRONIC automatic with Adaptive Transmission Control. Steering-wheel-mounted paddle shifters are included when the 1 Series Coupe is equipped with the optional Sport Package and automatic transmission. But whichever engine and transmission are in the 1 Series, innovative engineering makes it possible to enjoy outstanding performance, reduced emissions, and fewer trips to the pump.

¹ Manual transmission; 5.2 seconds, STEPTRONIC automatic. BMW AG test results. BMW urges you to obey all posted speed laws and always wear safety belts.

² Manual transmission; 6.7 seconds, STEPTRONIC automatic. BMW AG test results. BMW urges you to obey all posted speed laws and always wear safety belts.



You. The Road. One.

Only BMW could endow the 1 Series with the precise engineering and performance innovations worthy of “The Ultimate Driving Machine.®” It starts with classic BMW rear-wheel drive and near-perfect 50/50 weight distribution for balanced handling when accelerating and braking on straightaways and in turns. An aluminum double-pivot front suspension, and a five-link fully independent rear suspension made of lightweight steel further hone its lightning-quick responsiveness.

Even in the most slippery conditions, BMW’s Dynamic Stability Control (DSC)¹ and Dynamic Traction Control (DTC) help keep the 1 Series Coupe stable and going in the intended direction. Optional Active Steering automatically adjusts the steering ratio based on vehicle speed, for more immediate control at low to medium speeds, and more stability at highway speeds.

¹ DSC system on the 135i Coupe is specifically designed for performance-oriented driving.

1 Series Coupe Exterior Paints

Non-metallic

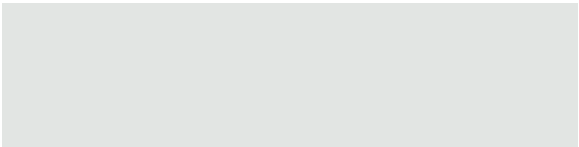

■ 300 Alpine White



■ A61 Crimson Red

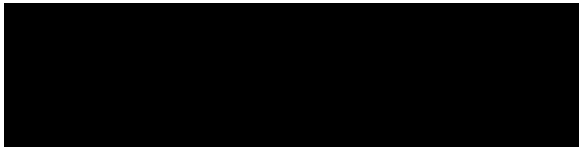

■ 668 Jet Black

Metallic



□ A79 Sedona Red Metallic



□ A72 Cashmere Silver Metallic



□ 354 Titanium Silver Metallic



□ A22 Sparkling Graphite Metallic



□ A51 Montego Blue Metallic



□ A35 Monaco Blue Metallic

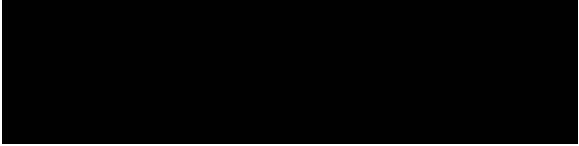

□ 475 Black Sapphire Metallic

Please note: Due to color monitor and printer capabilities, colors shown may not appear on screen and print out accurately.

- Standard equipment
- Optional equipment

Courtesy of:
www.1addicts.com

1 Series Coupe Upholsteries and Interior Trims

Leatherette upholsteries



■ KAA5 Taupe Leatherette



■ KASW Black Leatherette

Please note: Due to color monitor and printer capabilities, colors shown may not appear on screen and print out accurately.

- Standard equipment
- Optional equipment
- ▲ No-cost option

Leather upholsteries



□ LWB4 Savanna Beige Boston Leather



□ LWA5 Taupe Boston Leather



□ LWAL Gray Boston Leather



□ LWD1 Coral Red Boston Leather

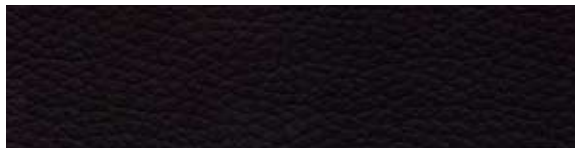

□ LWSW Black Boston Leather

Interior trims

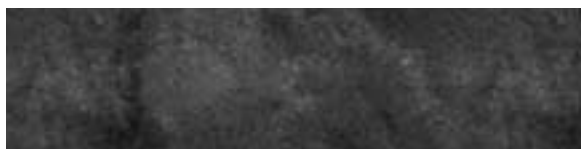

■ 4AS Gray Poplar Wood



▲ 4A3 Burl Walnut Wood

















▲ 4MG Aluminum

1 Series Coupe Recommended Color Combinations

Materials

Leatherette ■

Boston Leather □

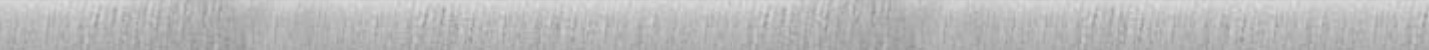
Upholstery colors		KAA5 Taupe	KASW Black	LWB4 Savanna Beige	LWA5 Taupe	LWAL Gray	LWD1 Coral Red	LWSW Black
Exterior paints								
300 Alpine White Non-metallic ■		●	●	●	●	●	●	●
A61 Crimson Red Non-metallic ■		●	●	●	●	●	●	●
668 Jet Black Non-metallic ■		●	●	●	●	●	●	●
A79 Sedona Red Metallic □		●	●	●	●	●		●
A72 Cashmere Silver Metallic □		●	●		●	●	●	●
354 Titanium Silver Metallic □		●	●	●	●	●	●	●
A22 Sparkling Graphic Metallic □		●	●	●	●	●	●	●
A51 Montego Blue Metallic □		●	●	●	●	●		●
A35 Monaco Blue Metallic □		●	●	●	●	●		●
475 Black Sapphire Metallic □		●	●	●	●	●	●	●
Interior trims								
4AS Gray Poplar Wood ■								
4A3 Burl Walnut Wood ▲								
4MG Aluminum ▲								

- Standard
- Optional
- ▲ No-cost option

Please note: Due to color monitor and printer capabilities, colors shown may not appear on screen and print out accurately.

Equipment

Performance and efficiency	128i	135i
3.0-liter dual overhead cam (DOHC), 24-valve inline 230-hp 6-cylinder engine with composite magnesium/aluminum engine block, Valvetronic, and Double-VANOS steplessly variable valve timing	●	
3.0-liter dual overhead cam (DOHC), 24-valve inline turbocharged 300-hp 6-cylinder engine with twin-turbo technology, piezo fuel injection, and Double-VANOS steplessly variable valve timing		●
Electronic throttle control	●	●
6-speed manual transmission	●	●
6-speed STEPTRONIC automatic transmission with Adaptive Transmission Control	○	○
Steering-wheel-mounted paddle shifters ¹	○	○

Handling, ride and braking	128i	135i
Dynamic Stability Control (DSC), including Brake Fade Compensation, Start-off Assistant, Brake Drying, and Brake Stand-by features, with Dynamic Traction Control (DTC)	●	●
Extensive aluminum componentry, including front suspension components (forged-aluminum lower arms); subframe; steering rack; and brake components	●	●
Aluminum double-pivot spring and strut-type suspension	●	●
Five-link fully independent rear suspension in lightweight steel	●	●
Front and rear anti-roll (stabilizer) bars	●	●
Twin-tube gas-pressure shock absorbers	●	●
Sport suspension calibration	□	●
4-wheel ventilated anti-lock disc brakes with Dynamic Brake Control (DBC)	●	●
Electric power steering with Servotronic power assist	●	●
Active Steering	○	○

- Standard
- Optional
- Included in Sport Package
- ◇ Included in Premium Package
- ★ Included in Cold Weather Package

¹ Requires and is automatically included with optional Sport Package and STEPTRONIC automatic transmission.
² Run-flat tires do not come equipped with spare tire and wheel.
³ Performance tires are not recommended for driving in snow and ice. Due to low-profile tires, please note: wheels, tires and suspension parts are more susceptible to road hazard and consequential damages.

Exterior	128i	135i
Star Spoke (Style 256) 17 x 7.0 cast alloy wheels and 205/50R run-flat ² all-season tires	●	
Star Spoke (Style 264) cast alloy wheels, 18 x 7.5 front, 18 x 8.5 rear; 215/40R front, 245/35R rear run-flat ² performance tires ³		●
Star Spoke (Style 262) cast alloy wheels, 17 x 7.0 front, 17 x 7.5 rear; 205/50R front, 225/45R rear run-flat ² performance tires ³	□	
Star Spoke (Style 142) 17 x 7.0 cast alloy wheels and 205/50R run-flat ² all-season tires		○
Xenon Adaptive Headlights with auto-leveling, and Cornering Lights	○	●
Halogen free-form front foglights	●	
High-intensity headlight washers	★	●
Heated dual power mirrors and heated windshield washer jets	●	●
Chrome-plated exhaust tips	●	
Black chrome-plated exhaust tips		●
Gray-band windshield	●	●
Integrated rear spoiler		●
Aerodynamic kit		●
Chrome-line exterior trim	●	●
Shadowline exterior trim	□	□
Metallic paint	○	○

Style 256



Style 264



Style 262



Style 142



Equipment

Interior seating and trim	128i	135i
8-way adjustable front seats, including 2-way headrests	●	●
Manual height adjustment for front passenger seat	●	●
8-way power front seats with 2-way manual headrests and driver memory with 2 presets for seat and exterior mirror positions	○/◇	○/◇
8-way adjustable front sport seats with adjustable side bolsters, 2-way headrests and thigh support	□	□
8-way power front sport seats with adjustable side bolsters, 2-way manual headrests and thigh support, and driver memory with 2 presets for seat and exterior mirror positions ⁴	□	□
4-way adjustable power lumbar support for front seats	◇	◇
Leatherette upholstery	●	●
Boston Leather upholstery	○/◇	○/◇
Gray Poplar Wood trim	●	●
Aluminum trim	▲	▲
Burl Walnut Wood trim	▲	▲
3-stage heated front seats	○/★	○/★
3-spoke leather-wrapped multi-function sport steering wheel with audio and hands-free phone ⁵ controls	●	●
3-spoke M leather-wrapped multi-function sport steering wheel with audio and hands-free phone ⁵ controls		□
Split fold-down rear seats	●	●
Ski bag	★	★

- Standard
- Optional
- Included in Sport Package
- ◇ Included in Premium Package
- ★ Included in Cold Weather Package
- ▲ No-cost option

⁴ Optional power seats or Premium Package required.
⁵ If equipped with optional Premium Package or BMW Assist™ Safety Services with **Bluetooth**® wireless technology. Requires BMW-approved **Bluetooth** enabled mobile phone.

Comfort and convenience	128i	135i
Engine Start/Stop button	●	●
Comfort Access keyless entry with multi-function remote control	○	○
2-way power glass moonroof with “one-touch” operation, sliding interior sunshade, and wind deflector	●	●
Automatic climate control – includes micro-filter, automatic air recirculation, left/right temperature control, MAX A/C, heat at rest, and recall of individual user settings	●	●
Front-door storage compartments	●	●
Front-seat center armrest	●	●
Front-seat cupholders	●	●
Rear seat with fold-down center armrest and storage bin	●	●
Tilt/telescopic steering-wheel column	●	●
Park Distance Control (PDC) (rear only)	○	○
Interior and power-adjustable folding exterior mirrors with automatic-dimming function	◇	◇
Digital interior mirror compass	◇	◇
Power front windows with “one-touch” up/down operation	●	●
Dynamic Cruise Control	●	●
BMW Ambiance interior lighting along doors and sides of rear cabin	◇	◇
Locking glovebox	●	●
Rain-sensing windshield wipers and Automatic headlight control	●	●
Integrated 3-button Universal garage-door opener	◇	◇
Pre-wiring for BMW center installation of mobile phone, alarm system	●	●

Equipment

Audio system	128i	135i
Anti-theft AM/FM stereo CD/MP3 player audio system with 10 speakers, Radio Data System (RDS), Auto-Store and 3-channel FM diversity antenna	●	●
Premium Hi-Fi anti-theft AM/FM stereo CD/MP3 player audio system with upgraded speakers (including 2 subwoofers), Digital Sound Processing (DSP), Radio Data System (RDS), Auto-Store and 3-channel FM diversity antenna; displays MP3 song title and artist	○	○
Auxiliary audio input for portable music players located in the center armrest	●	●
Pre-wiring for BMW center installation of 6-disc CD/MP3 changer, ⁶ satellite radio	●	●
SIRIUS Satellite Radio	○	○
iPod® and USB adaptor (includes cable connector)	○	○
HD Radio™ – receive free, digital AM/FM broadcasts in clear, static-free quality sound; “multicast” FM stations; and innovative data services. Can be ordered with Premium Hi-Fi audio system	○	○
Instrumentation and controls	128i	135i
Service Interval Indicator with miles-to-service readout	●	●
Check Control vehicle monitor system with pictogram display, oil status display, and Condition Based Service indicator	●	●
Tire Pressure Monitor	●	●
On-board computer with Check Control – provides feedback on the vehicle’s operating status: oil level indicator and distance to next service appointment/oil change, as well as other detailed information, such as spark plug and micro-filter status. It also provides travel information – travel range on remaining fuel, external temperature, and more	●	●
BMW Navigation system with Voice Command System and Real Time Traffic Information (where available); iDrive system with high-function onboard computer and Controller, with 6 programmable memory keys	○	○

Safety and security	128i	135i
Anti-lock braking system (ABS)	●	●
Adaptive Brake Lights	●	●
BMW’s Advanced Safety System for integrated deployment of passive and active safety systems	●	●
Front and rear Head Protection System (HPS)	●	●
Driver’s and passenger’s front airbag supplemental restraint system (SRS) with advanced technology: dual-threshold, dual-stage deployment; and front-passenger seat sensors designed to prevent unnecessary airbag deployment	●	●
Front passenger seat-occupation recognition with Passenger’s Airbag Off indicator	●	●
Automatic safety-belt pretensioners at front seating positions	●	●
Front-seat-mounted front side-impact airbags	●	●
Interlocking door anchoring system to help protect against door intrusion in side impacts	●	●
Central locking system with center console switch (leaves gas filler door unlocked), double-lock feature and 2-step unlocking	●	●
Coded Driveaway Protection	●	●
Automatic-locking retractors (ALR) on all passenger-seat safety belts for installation of child-restraint seat	●	●
LATCH attachments for child-restraint safety installation in rear seats	●	●
Crash sensor that automatically turns on hazard lights and interior lights, and unlocks doors	●	●
Programmable Daytime Running Lights	●	●
BMW Assist™ with Bluetooth® wireless technology for hands-free calling (with Bluetooth enabled mobile phone), phonebook downloading and speech recognition capabilities	○/◇	○/◇
BMW Services	128i	135i
BMW Ultimate Service™	●	●

- Standard
- Optional
- Included in Sport Package
- ◇ Included in Premium Package
- ★ Included in Cold Weather Package

⁶ Available as an accessory.

Packages

Premium Package	128i	135i
8-way power front seats with 2-way manual headrests and driver memory with 2 presets for seat and exterior mirror positions	◇	◇
4-way adjustable power lumbar support for front seats	◇	◇
Boston Leather upholstery	◇	◇
Interior and power-adjustable folding exterior mirrors with automatic-dimming function	◇	◇
Digital interior mirror compass	◇	◇
BMW Ambiance interior lighting along doors and sides of rear cabin	◇	◇
Integrated 3-button Universal garage-door opener	◇	◇
BMW Assist™ with Bluetooth ® wireless technology for hands-free calling (with Bluetooth enabled mobile phone), phonebook downloading and speech recognition capabilities	◇	◇

Sport Package	128i	135i
Star Spoke (Style 262) cast alloy wheels, 17 x 7.0 front, 17 x 7.5 rear; 205/50R front, 225/45R rear run-flat ⁷ performance tires ⁸	□	
8-way adjustable front sport seats with adjustable side bolsters, 2-way headrests and thigh support	□	□
8-way power front sport seats with adjustable side bolsters, 2-way manual headrests and thigh support, and driver memory with 2 presets for seat and exterior mirror positions ⁹	□	□
Sport suspension calibration	□	●
3-spoke M leather-wrapped multi-function sport steering wheel with audio and hands-free phone ¹⁰ controls		□
Steering-wheel-mounted paddle shifters ¹¹	○	○
Shadowline exterior trim	□	□

Cold Weather Package	128i	135i
Ski bag	★	★
3-stage heated front seats	★	★
High-intensity headlight washers	★	●



- Standard
- Optional
- ◇ Included in Premium Package
- Included in Sport Package
- ★ Included in Cold Weather Package

⁷Run-flat tires do not come equipped with spare tire and wheel.
⁸Performance tires are not recommended for driving in snow and ice. Due to low-profile tires, please note: wheels, tires and suspension parts are more susceptible to road hazard and consequential damages.

⁹Optional power seats or Premium Package required.
¹⁰If equipped with optional Premium Package or BMW Assist™ Safety Services with **Bluetooth** wireless technology. Requires BMW-approved **Bluetooth** enabled mobile phone.
¹¹Requires and is automatically included with optional Sport Package and STEPTRONIC automatic transmission.

Stand-alone Optional Equipment

Option Code		128i	135i
205	6-speed STEPTRONIC automatic transmission with Adaptive Transmission Control	○	○
2XA	Steering-wheel-mounted paddle shifters ¹²	○	
7XA	Steering-wheel-mounted paddle shifters ¹²		○
217	Active Steering	○	○
2CH	Star Spoke (Style 142) 17 x 7.0 cast alloy wheels and 205/50R run-flat ¹³ all-season tires		○
522	Xenon Adaptive Headlights with auto-leveling, and Cornering Lights	○	●
MET	Metallic paint	○	○
459	8-way power front seats with 2-way manual headrests and driver memory with 2 presets for seat and exterior mirror positions	○/◇	○/◇
LW	Boston Leather upholstery	○/◇	○/◇
4MG	Aluminum trim	▲	▲
4A3	Burl Walnut Wood trim	▲	▲
494	3-stage heated front seats	○/★	○/★
322	Comfort Access keyless entry with multi-function remote control	○	○

Option Code		128i	135i
507	Park Distance Control (PDC) (rear only)	○	○
677	Premium Hi-Fi anti-theft AM/FM stereo CD/MP3 player audio system with upgraded speakers (including 2 subwoofers), Digital Sound Processing (DSP), Radio Data System (RDS), Auto-Store and 3-channel FM diversity antenna; displays MP3 song title and artist	○	○
655	SIRIUS Satellite Radio	○	○
6FL	iPod® and USB adaptor (includes cable connector)	○	○
653	HD Radio™ – receive free, digital AM/FM broadcasts in clear, static-free quality sound; “multicast” FM stations; and innovative data services. Can be ordered with Premium Hi-Fi audio system	○	○
609	BMW Navigation system with Voice Command System and Real Time Traffic Information (where available); iDrive system with high-function onboard computer and Controller, with 6 programmable memory keys	○	○
639	BMW Assist™ with Bluetooth ® wireless technology for hands-free calling (with Bluetooth enabled mobile phone), phonebook downloading and speech recognition capabilities	○/◇	○/◇



- Standard
- Optional
- ◇ Included in Premium Package
- Included in Sport Package
- ★ Included in Cold Weather Package
- ▲ No-cost option

¹² Requires and is automatically included with optional Sport Package and STEPTRONIC automatic transmission.

¹³ Run-flat tires do not come equipped with spare tire and wheel.

Courtesy of:
www.1addicts.com

Technical Data

Weight		128i	135i
Unladen weight	lbs	3252 (3329)	3732 (3384)
Engine			
Liters/type/valves per cylinder		3.0/inline 6/4	Turbocharged 3.0/inline 6/4
Displacement	cu cm	2996	2979
Nominal output @ rpm	hp	230 @ 6500	300 @ 5800
Maximum torque @ rpm	lb-ft	200 @ 2750	300 @ 1400-5000
Performance			
Top speed ¹⁴	mph	130	150
Acceleration 0-60 mph ¹⁵	sec	6.1 (6.7)	5.1 (5.2)
Tires and wheels			
Tire dimensions	standard	205/50R	front: 215/40R rear: 245/35R
Wheel dimensions	standard	17 x 7.0	front: 18 x 7.5 rear: 18 x 8.5
Material	standard	cast alloy	cast alloy

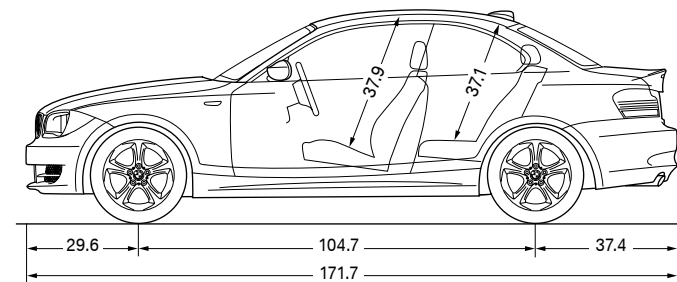
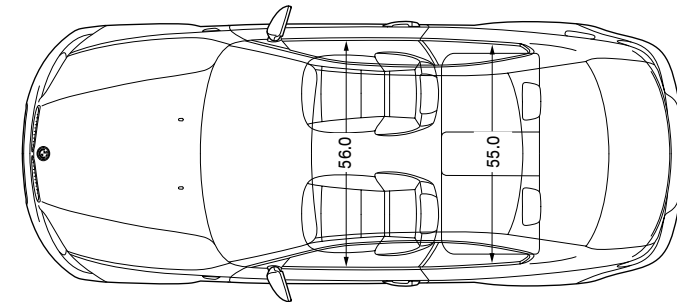
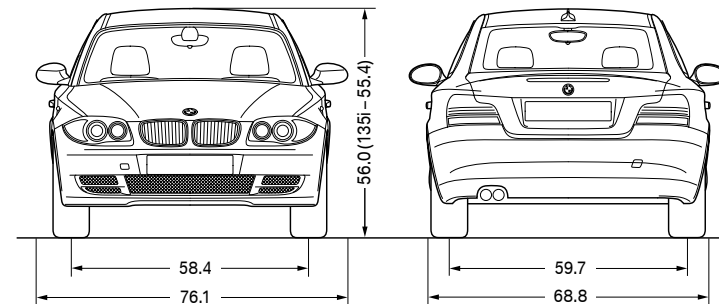

All technical information is preliminary.
 Figures in () apply to vehicles with automatic transmission.

¹⁴ Top speed limited electronically. All-season tires limited to 130 mph;
 Sport Package top-speed limiter increased to 150 mph.

¹⁵ BMW AG test results. BMW urges you to obey all posted speed laws
 and always wear safety belts.

Illustrations above: all dimensions shown in inches.

Courtesy of:
www.1addicts.com

U.S. Importer: BMW of North America, LLC, Woodcliff Lake, NJ 07677. All illustrations and specifications contained in this brochure are based on the latest product information available at the time of printing. BMW reserves the right to make changes at any time, without notice, in colors, materials, equipment, specifications and models. BMW may, subject to legal requirements, determine the Model Year designation of its vehicles. The Model Year designation on any particular model may be longer or shorter than 12 months. Some vehicles pictured may contain non-U.S. equipment. Some models may be shown with optional equipment. While BMW NA makes all diligent efforts to provide accurate information in this brochure, there is no guarantee or warranty of accuracy. Furthermore, we do not assume any liability for the accuracy or completeness of information presented. Further information can be obtained from bmwusa.com.

©2007 BMW of North America, LLC. Not to be reproduced wholly or in part without written permission from BMW of North America. The BMW name, model names and logo are registered trademarks. The Bluetooth word mark and logos are owned by the Bluetooth SIG, Inc. and use of such marks by BMW is under license. iPod® is a registered trademark of Apple Inc. Other trademarks and trade names are those of their respective owners.

More about BMW

bmwusa.com
1-800-334-4BMW



The Ultimate
Driving Machine®

